

# Zigzag Sewing Machine

Instruction Manual TZ1-B652

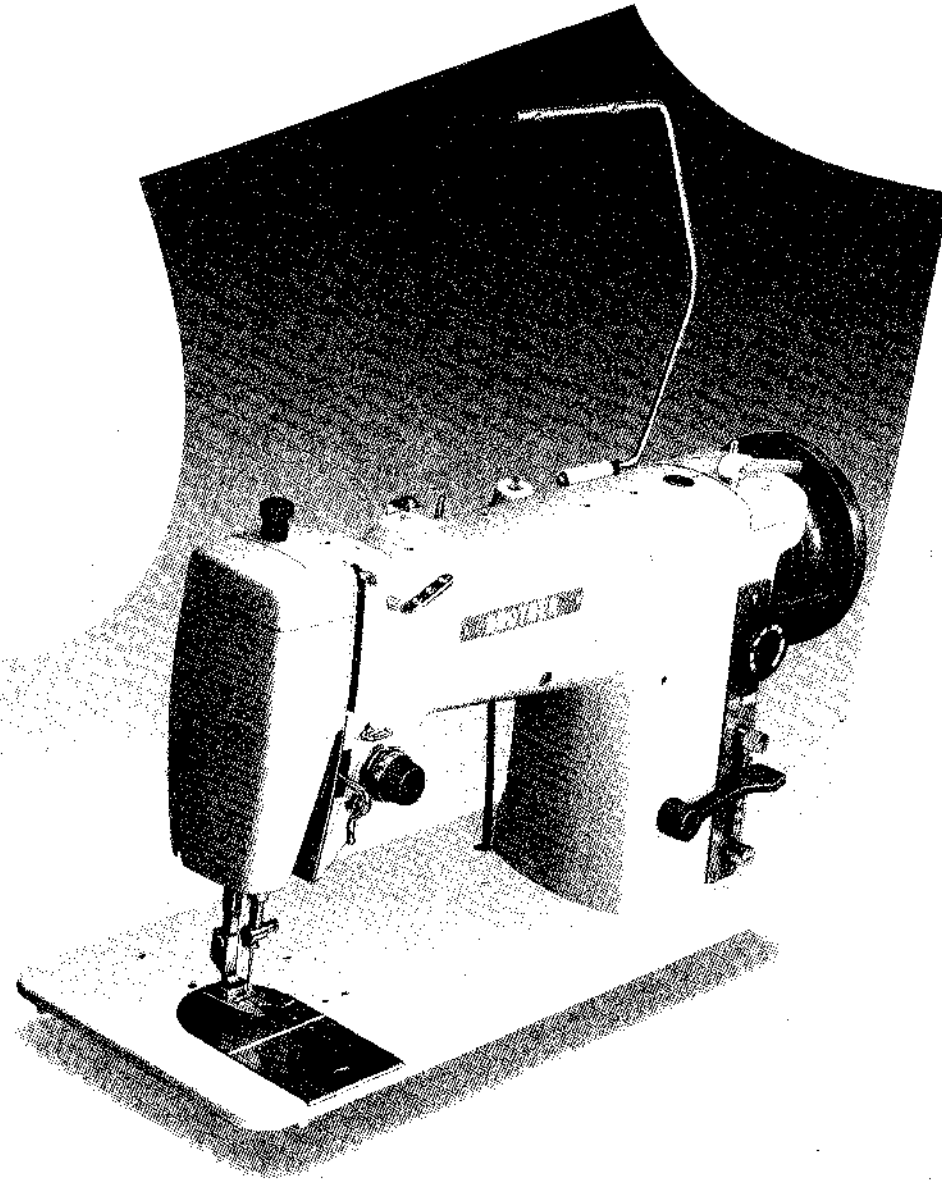

brother®

# CONTENTS

<b>Name of Components</b> .....	1
Arm and bed (head) .....	1
Table and stand .....	2
<b>Component: Their Function and Operation</b> .....	3
Major components .....	3
Presser adjusting screw .....	3
Needle .....	4
Knee-operated presser foot lifter and zigzag width adjuster .....	5
Needle bar support clamping knob .....	6
Zigzag lever and stopper thumb screw .....	6
<b>How to Use Each Part</b> .....	7
Presser foot .....	7
Needle plate .....	7
Feed dog .....	8
<b>Accessories</b> .....	9
<b>Preparation for Sewing</b> .....	10
Preparation thread .....	10
Upper thread .....	14
Picking up the lower thread .....	15
Caution in sewing .....	16
The relation of fabrics, needle and threads .....	17
<b>Sewing</b> .....	18
Straight stitch .....	18

Tension control of straight stitch .....	20
Zigzag sewing .....	21
<b>Applied sewing</b> .....	23
Sewing lace on .....	23
Patching up .....	23
Shirring .....	23
Tacking a padding .....	24
Coat hemming .....	24
Trousler waist lining .....	24
Reinforcing stitching .....	25
Overlock and hem stitch .....	25
Embroidering .....	25
<b>Cleaning of Feed Dog and Shuttle Race Body</b> .....	28
<b>Oiling</b> .....	29
<b>Basic Adjustments</b> .....	31
Adjustment of the bobbin winder guide .....	31
Adjustment of the strength of the thread take-up spring .....	31
<b>Trouble and Check Point</b> .....	33
<b>How to Set the Machine</b> .....	35
Table and leg .....	35
Head .....	35
<b>Specification</b> .....	37

## Name of Components

Arm and bed (head)

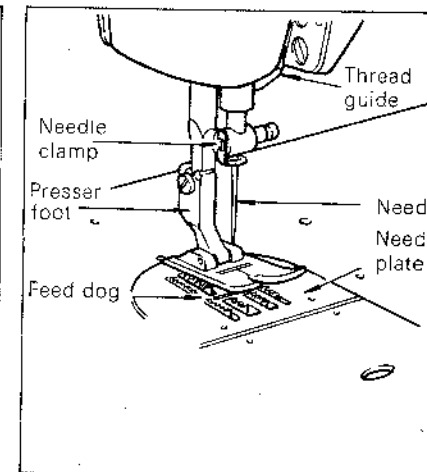
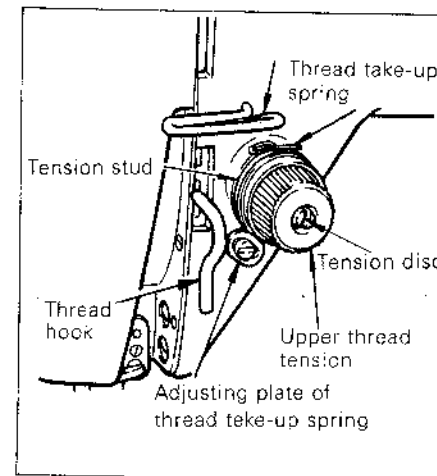
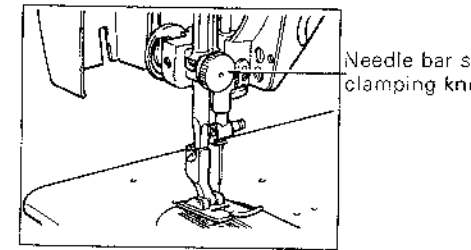
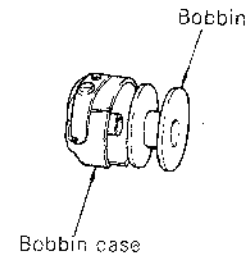
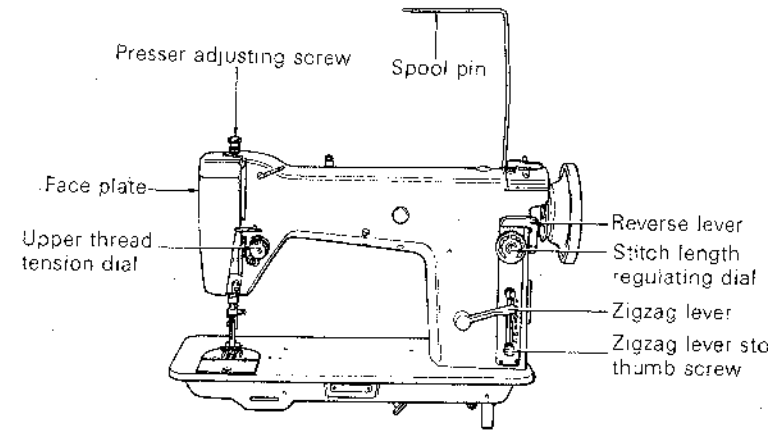

## Component: Their Function and Operation

### Major components

#### Stitch length regulating dial and reverse lever: Function and operation (Stitch length adjusting and forward-reverse sewing)

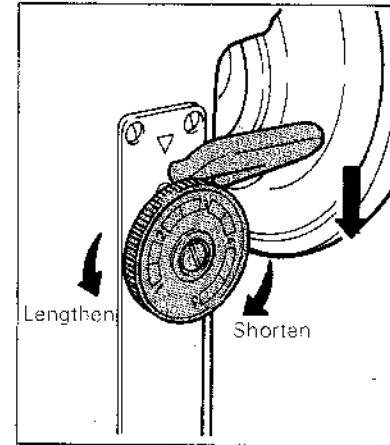
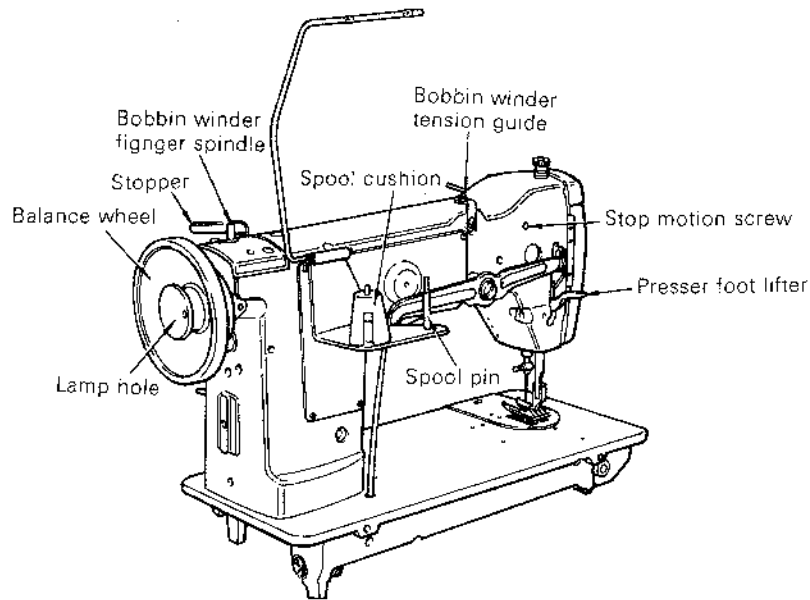

#### Stitch length regulating dial (1): Function and operation

- This dial is used for adjusting stitch length in forward-reverse sewing. Turning the dial counterclockwise increases the length of the stitch.

- Numbers on the dial indicate degrees of stitch length.

**Note:** If the dial is set at Number 0, the machine won't feed material.

#### Reverse lever (2): Function and operation

- With the reverse lever (2) pressed down all the way, the machine feeds material backward keeping the same stitch length as in forward sewing.

**Note:** The reverse lever is the self returning type.

Releasing the lever sets the machine automatically back to forward sewing.

### Table and stand

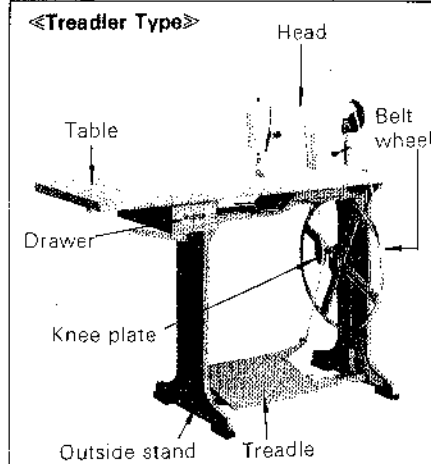
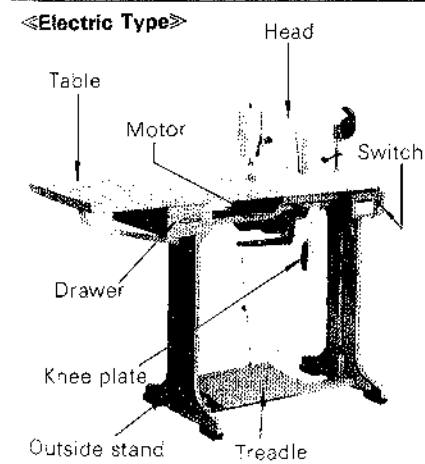

#### Presser adjusting screw: Function and operation

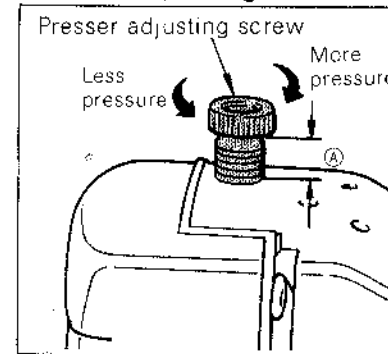

Adjust presser foot according to the kind of material.

- Turning the screw clockwise increases the pressure and turning it counterclockwise reduces it.

When sewing thin material, weaken the pressure to prevent wrinkling.

When sewing thick material, increase the pressure to ensure positive feeding.

## Needle

Use the needle No. DB × 1 (#9, #11, #14, #16, #18).

The needle set to the machine as the standard accessory is No. DB × 1 (#14).

Needle number is marked on the haft of the needle.

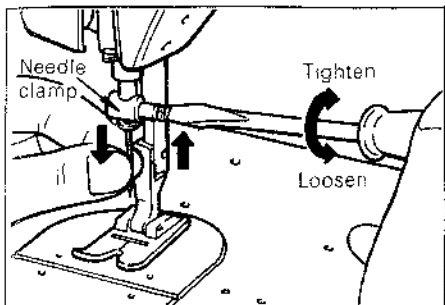

### To change the needle

1. Raise the needle bar (1) up highest.
2. Use a screwdriver to loosen the needle clamp screw (2).
3. Pull out the needle (3) downward.
4. Hold a new needle (4) with its groove (B) facing your side. (Direct the cutout (A) toward the presser bar.)
5. Insert the needle into the needle bar's needle hole all the way up.
6. Tighten the needle clamp screw (2) securely by means of a screwdriver.
7. Turn the balance wheel slowly and ascertain that the needle point falls right in the center of the needle hole.

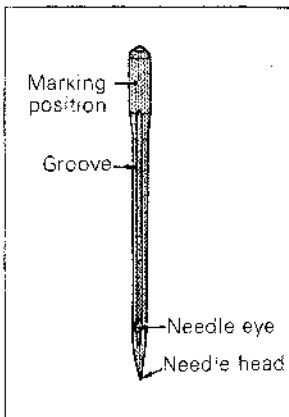

### To check the needle

1. The sewing needle must be always straight and sharp to have smooth sewing.
2. To check if the needle is bent, put the flat side of the needle down on a slide plate as shown in left figure.

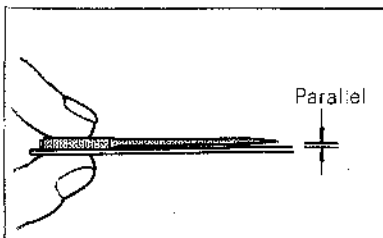

## Knee-operated presser foot lifter and zigzag width adjuster

The knee operated system of this sewing machine is used as either presser foot lifter or zigzag width adjuster.

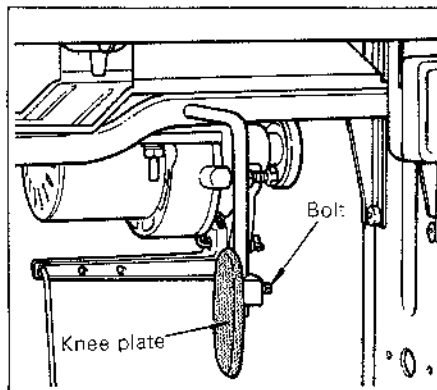

### As knee-operated presser foot lifter

1. Loosen the bolt.
2. Adjust the knee plate by knee.
3. Tighten the bolt.

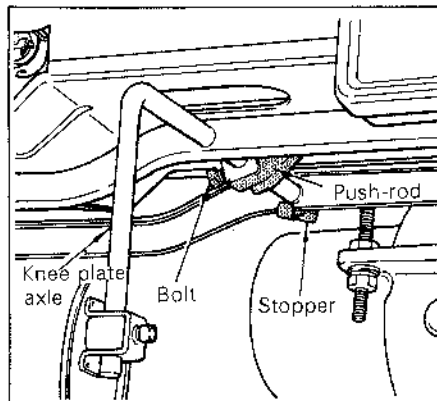

### As knee-operated zigzag width adjuster

1. Loosen the bolt of the push rod and the stopper. Pull out the knee plate from the frame.

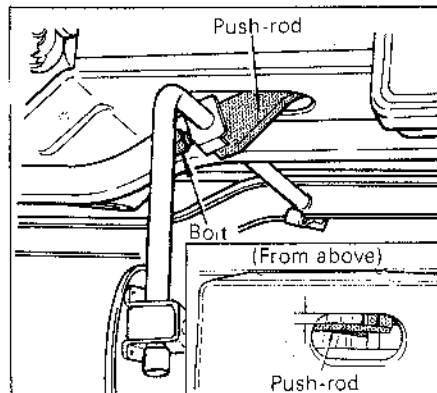

2. Reconstruct the push rod toward yourself. Attach the knee plate axle and tighten the bolt on the stopper.
3. Fix the push-rod about 12 mm from the hole of the oil plate.

NOTE: The space between the nail bar and the push rod should be about 2 mm so that the

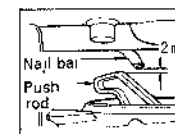

knee-operated presser foot lifter can have a little non-operating space.

## Needle bar support clamping knob: Function and operation

In straight stitch sewing, this clamp positively prevents sidewise movement of the needle bar support (and needle bar) — even when the zigzag lever was accidentally pressed down — thus assures the same straight stitches as may be obtained on a straight stitch sewing machine.

Turning the knob switches the machine to straight or zigzag stitch sewing.

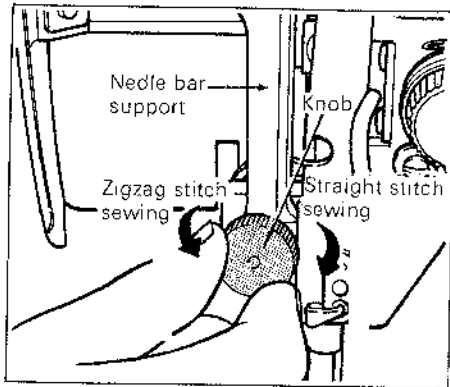

### Straight stitch sewing

Make sure that the zigzag lever is up at Number 0; turn the knob clockwise all the way to tighten the needle bar support securely.

### Zigzag stitch sewing

Turn the knob counterclockwise all the way to free the needle bar support.

- Unless the zigzag lever is up at Number 0, the needle bar support cannot be fastened.

**Note:** The clamp positively fastens the needle bar support for beautiful straight stitching even when the support comes to have sidewise play due to wear of machine parts.

## Zigzag lever and its stopper thumb screw

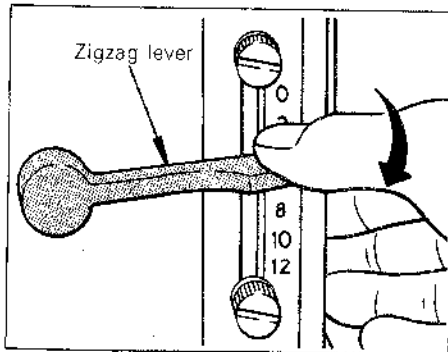

Zigzag lever is used for regulating the width of the needle's zigzag motion and the larger the number, the greater the width of the needle's zigzag width.

These thumb screws are used to limit zigzag width and the upper zigzag stopper thumb screw is for smaller zigzag width and the lower zigzag stopper thumb screw for larger zigzag widths.

**Note:** Use a screwdriver to turn them if too tight to turn either way with your fingers.

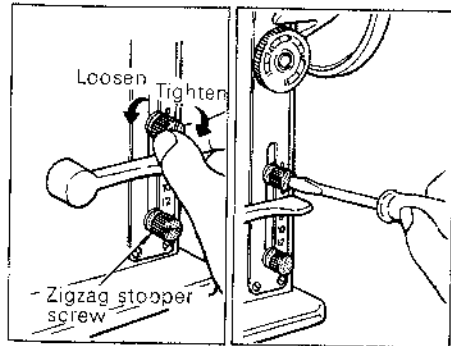

## How to Use Each Part

### Presser foot

#### (1) Removing

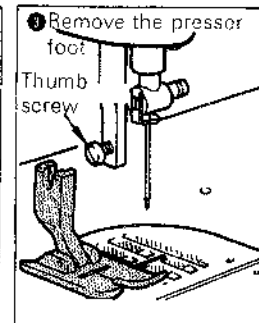
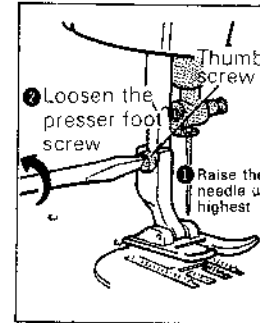

#### (2) Installing

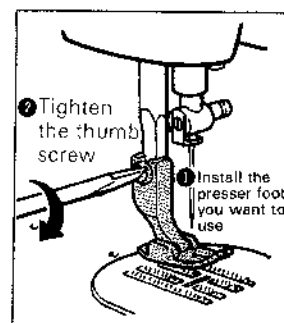

### Needle plate

#### (1) Removing

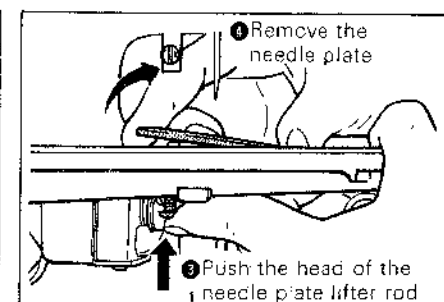
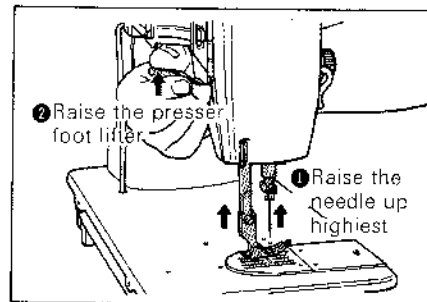

#### (2) Installing

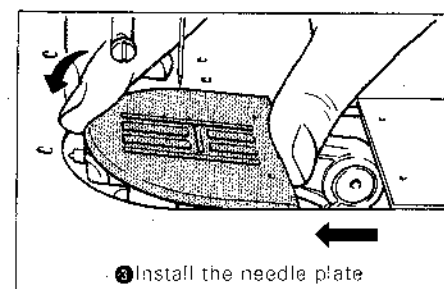
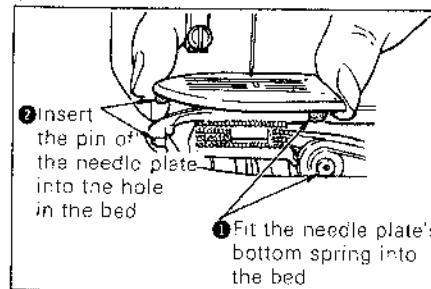

**Note:** Unless the needle plate is set to the bed correctly, feed dog will not work sufficiently.

## Feed dog

### (1) Removing

1. Turn the balance wheel until the needle barely reaches its highest position.
2. Remove the presser foot and the needle plate.
3. Tilt the head.
4. Loosen the two round nut and remove the feed dog.

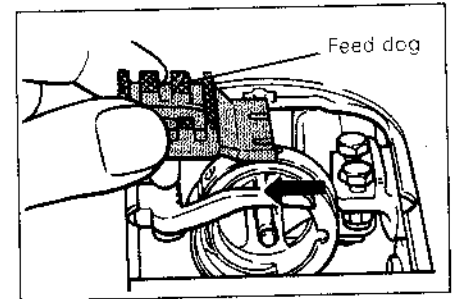
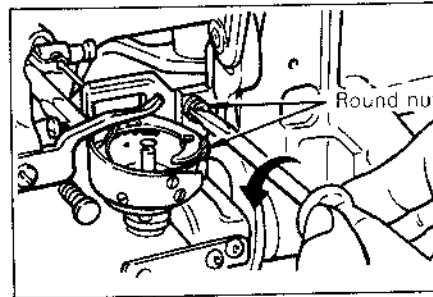

**Note:** Don't remove but only loosen the round nuts.

### (2) Installing

Install the feed dog in the converse way of removing.

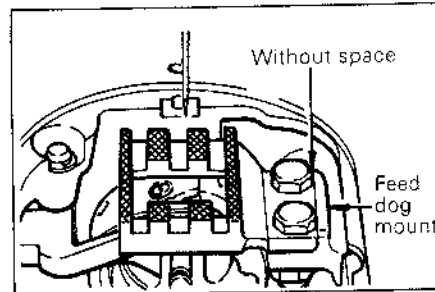

**Note:** Install the feed dog so that its end surface contacts the feed dog mount without space.

## Preparing for Sewing

### Preparing thread

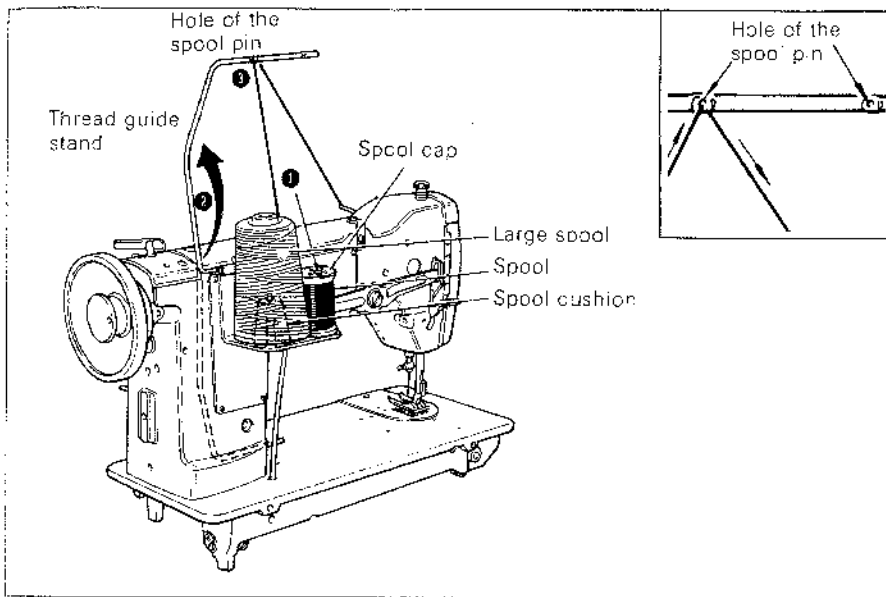

1. Place a spool of thread on the spool stand.  
\*When using big bobbin, put it on the spool cushion.
2. Set up the thread guide stand.
3. Pass the thread through a hole of the spool pin.

#### Spool cap

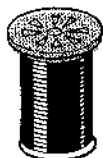

- \* Put the spool cap on the side of the groove of the spool.

### (1) Removing the bobbin case

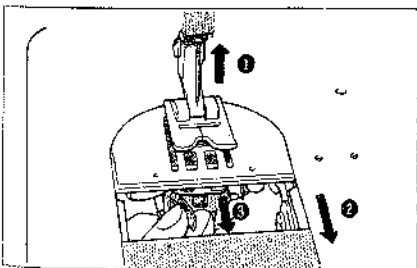

1. Turn the balance wheel toward yourself until the needle is up highest
2. Pull the slide plate toward yourself.
3. Pull out the bobbin case slipping your hand under the table.

### (2) Removing the bobbin out of the case

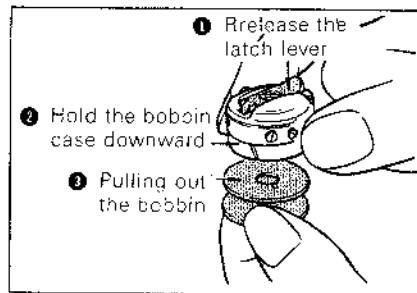

**Note:** The bobbin won't come out if the bobbin case lock downward, while you hold the bobbin case latch lever.

### (3) Winding thread on the bobbin

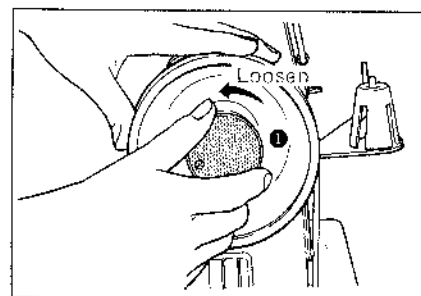

- 1 Hold the balance wheel with your left hand and loosen the stop motion screw with your right hand.

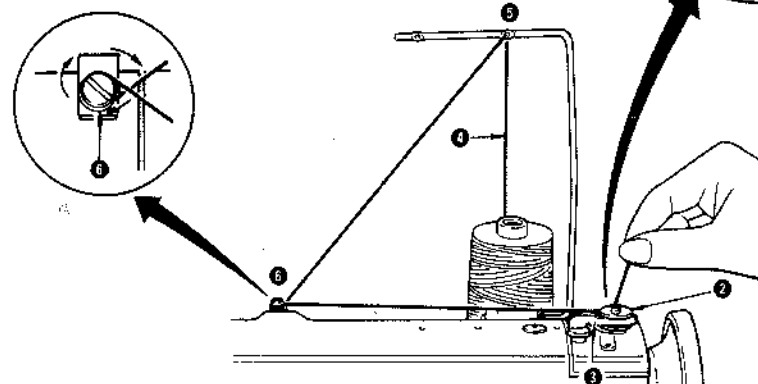
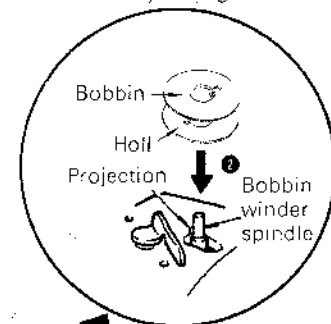

2. Place the bobbin on the bobbin winder spindle.
3. Push the bobbin winder finger in the groove.
4. Pull out the thread.
5. Pass the thread through a hole in the spool pin.

6. Pass the thread crossing between the discs of the bobbin winder tension guide.
7. Wind three or four turns of thread on the bobbin and keep the end of the thread and step into the treadle slowly.
8. When the bobbin is fully wound the bobbin winder finger automatically pulls away and stop the revolution of the bobbin.
9. Rewind the bobbin.
10. Tighten the stop motion screw.

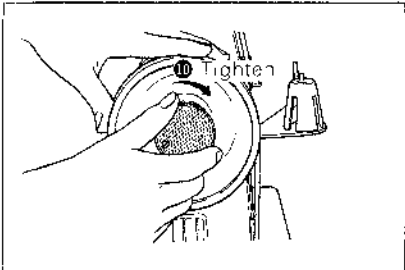

**(4) Threading the bobbin case**

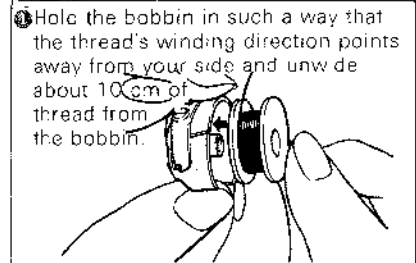

**Note:** The bobbin won't come into the bobbin case as the latch lever is held.

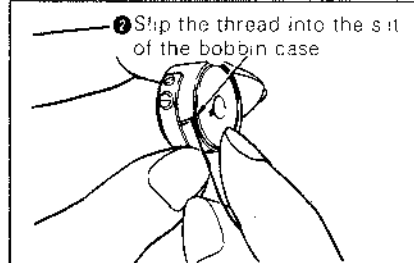

**Straight stitch sewing**

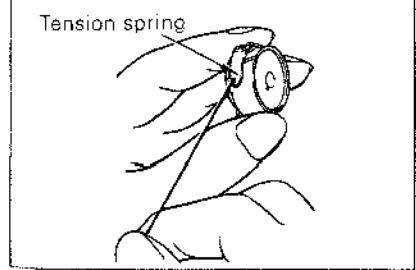

**Note:** In the case of straight stitch sewing don't pass the thread through the ecuel.

**Zigzag stitch sewing**

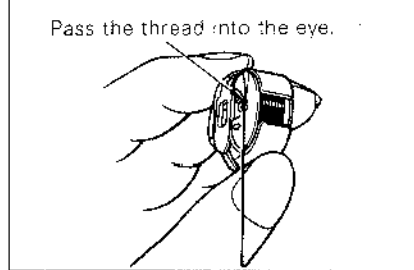

**(5) Installing the bobbin case**

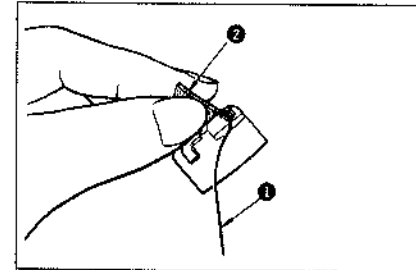

1. Pull the thread's end through the bobbin case until about 10 cm of thread is out.
  2. Hold the bobbin case latch lever.
- Note:** Open the latch lever widely.

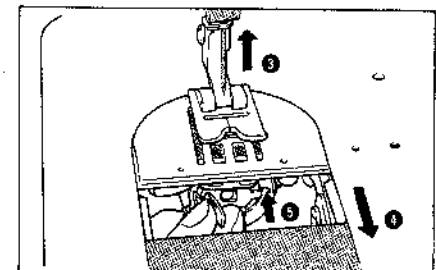

3. Turn the balance toward yourself until the needle is up highest.
  4. Pull the side toward yourself.
  5. Fit the bobbin case into the shuttle body's slot.
- Note:** If the bobbin case isn't fit surely, it will come out at the same time the machine starts.

## Upper thread

### Preparing

1. Turn the balance toward yourself the thread take-up lever is up highest.
2. Place the spool of thread on the spool stand and pass the thread in the proper steps is below.

**Note:** Carefully follow the steps described below, because the wrong threading makes sewing impossible.

### Threading

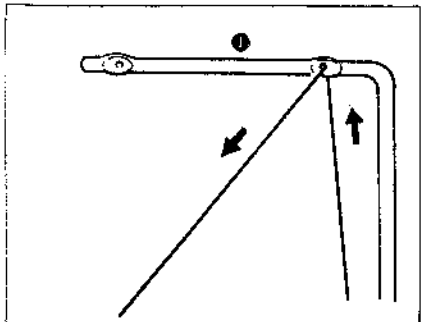
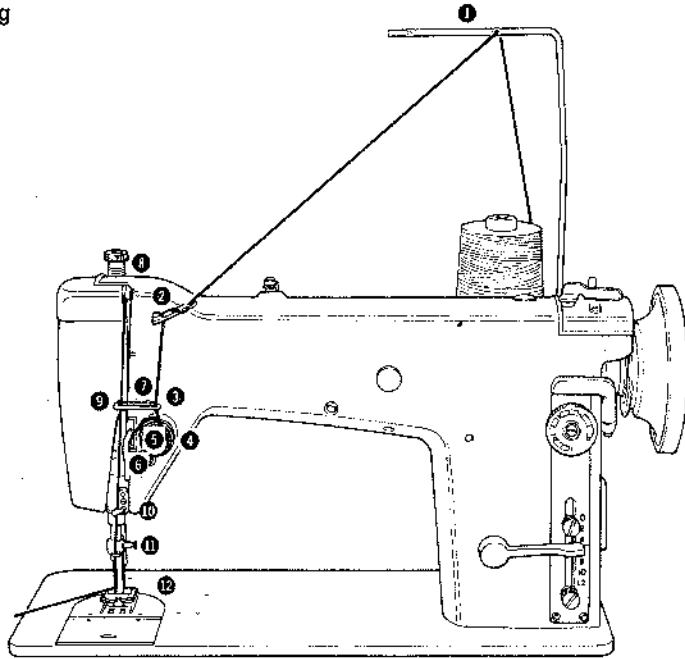

- 1 Pass the thread through the hole of the spool pin.

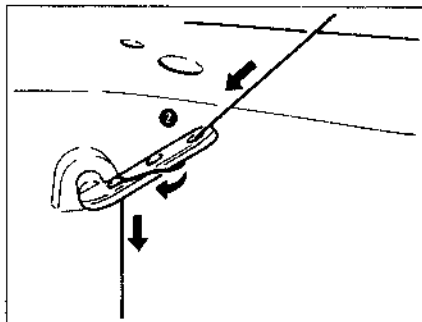

- 2 Pass the thread through the thread retainer.

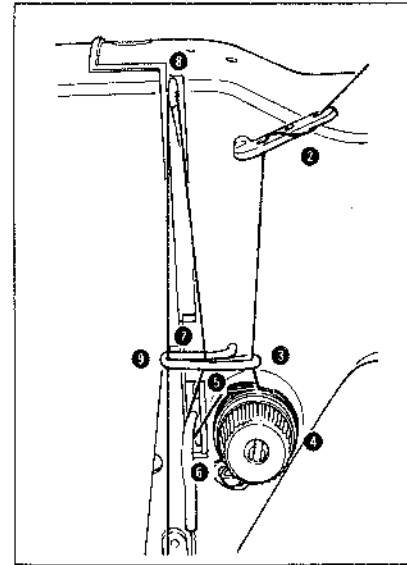

- 3 Pass the thread through the thread take-up guide.
- 4 Pass the thread between the two discs of the main upper thread tension regular.
- 5 Pass the thread through the thread take-up spring.
- 6 Pass the thread through the hook of the thread take-up spring.
- 7 Pass the thread through the thread take-up guide.
- 8 Pass the thread through the take-up lever.
- 9 Pass the thread through the thread take-up guide.

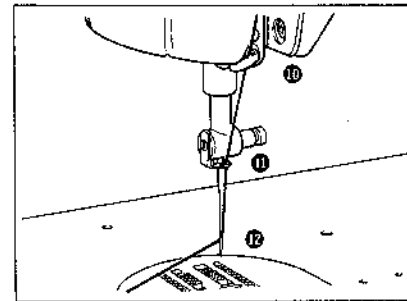

- 10 Pass the thread.
- 11 Pass the thread from your side toward the farther side of the table. Pull up the end of the thread about 10 cm.
- 12 Thread needle from front to back and draw the thread out about 6 inches (15 cm).

### Picking up the lower thread

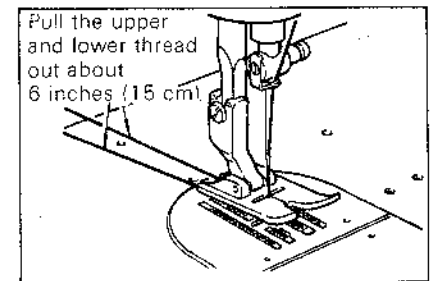
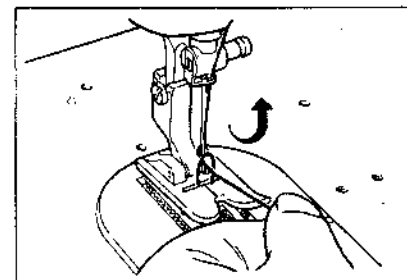

With your left hand hold the upper thread and with your right hand turn the balance wheel toward yourself. As the needle goes down and rises back, stop the the balance wheel and pull the upper thread when it is up highest. The upper thread catches the lower thread and comes up in loop from through the needle's plate hole. Just pull the lower thread.

### Caution in sewing

1. Use making sure that the bobbin fits into the shuttle body's slot. For particular details turn to "installing the bobbin case" in page 13.
2. Be careful not to pull the cloth when sewing. Turn to page 19 as to the stating. And when taking off the cloth never pull out the cloth toward yourself from the presser foot.







**Note:** Raise the needle up highest and take off the fabric after raising the presser foot.

3. Use the proper kind of needle for the thread's number. Turn to page 17 with to the fabric, the thread and the needle.
4. Never move the reverse lever with the needle down. As to the reverse lever, turn to the page 3.

The above caution is to prevent the thread from getting into the shuttle body, the needle plate and the needle hole from being damaged, and the sewing from being in a bad condition due to the needle breakage.

### The relation of fabrics, needles and threads.

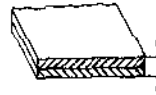
Note the following table thoroughly, as it relates to the various sewing.

	The relation of fabrics, needles and threads.		
	Sewing materials 	Thread size 	Needle size 
<b>Thin</b> 	Lawn	Cotton #80	#9
	Tricot	Synthetic #60	
	Georgette	Silk #50	
	Wool georgette	Silk or Synthetic #50	#11
<b>Medium</b> 	Gingham	Cotton #60~80	#11~14
	Thin jersey	Synthetic #60	#11
	Gabardine, Flano	Silk #50	
<b>Heavy</b> 	Denim	Cotton #50	#11~16
	Jersey	Synthetic #50	#11~14
	Tweed	Silk #80	#11~14

### The ply of thread

- Classification of use

Use the Z-ply thread for the upper thread.

Either the Z-ply thread or the S-ply thread can use for the lower thread.

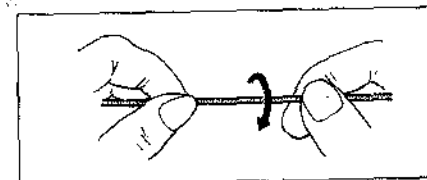

Z-ply

S-ply



- Discrimination (The way to discriminate)

Discriminate the ply of the thread following the right figure. Hold both ends of the thread with thumb and the forefinger and twist to the thread toward yourself with your left hand. When twisting, it is Z-ply, and when untwisting, it is S-ply.

# Sewing

## Straight stitch

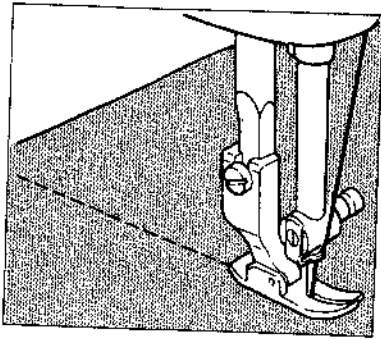
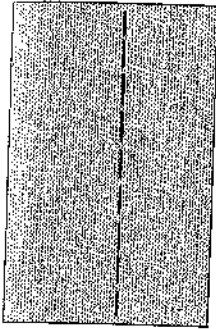

As the fabric is sent automatically by the function of the feed dog. Put your hand on the fabric only in order to guide it in the proper direction.

Setting the sewing machine as follows, the straight stitch can be sewn

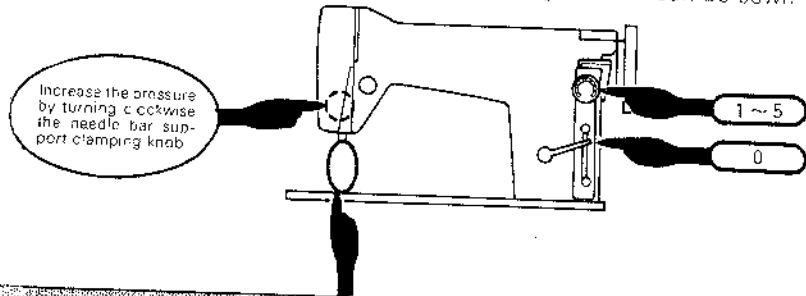

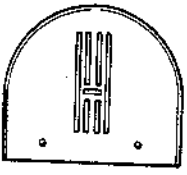
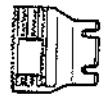
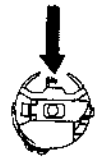
Presser	Needle plate	Feed dog	Bobbin case
 <b>Zigzag</b>	 <b>Zigzag</b>	 <b>Zigzag</b>	 Don't pass the thread into the eye.

With regard to how to change the part, turn to page 7 as to the presser foot and the needle plate, page 8 as to the feed dog and page 12 as to the way to pass the thread through the bobbin case.

### (1) Starting

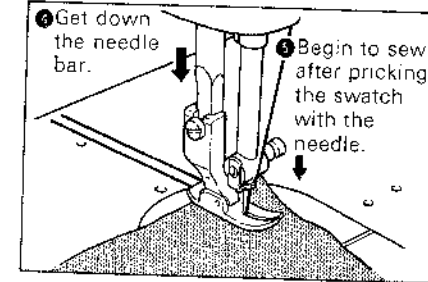
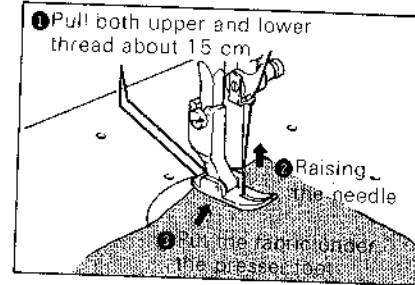

**Note:** beginning..... Sew after making sure that upper thread catches lower thread.  
Swatch has to be put between presser foot and feed dog. If not, feed dog will not work sufficiently.  
while sewing..... Do not pull the swatch by hand.

### (2) To finish sewing

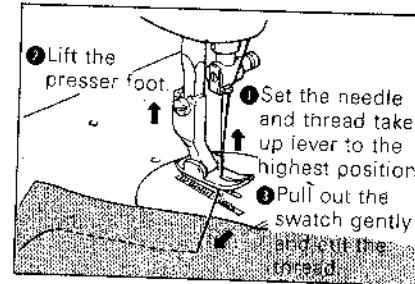

### (3) To fasten the final sewing

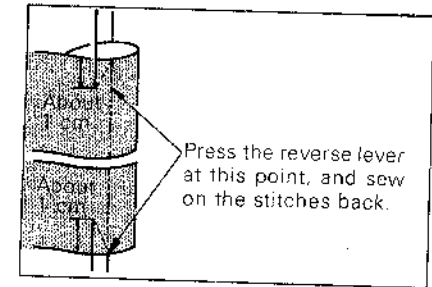

### (4) To change the sewing direction

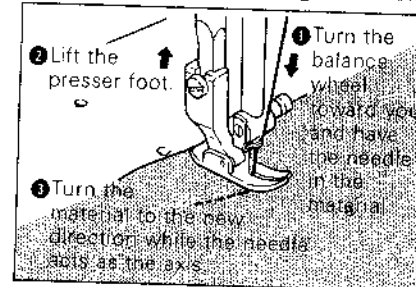

### Tension control of straight stitch

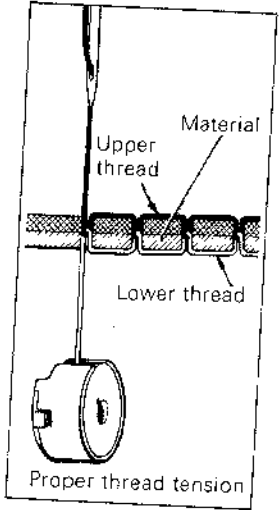

In the following case **2. Adjust the tension to the tension strength of lower thread.**

Upper/lower thread tension have to be adjusted properly when sewing. Otherwise, any troubles might happen such as uneven sewing stitches, seam with wrinkles, breakage of stitches, etc. In such cases, adjust as follows:

1. Adjust the lower thread tension, so that lower thread can pull smoothly.
2. Adjust the upper thread tension.

**2. Adjust the tension to the tension strength of lower thread.**

### Zigzag sewing

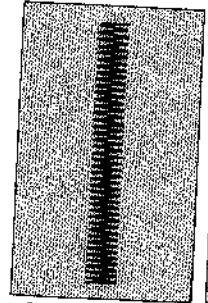

Satin stitch

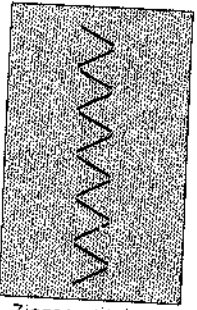

Zigzag stitch

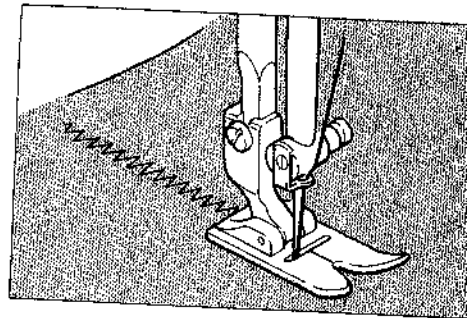

For zigzag sewing, set as below.

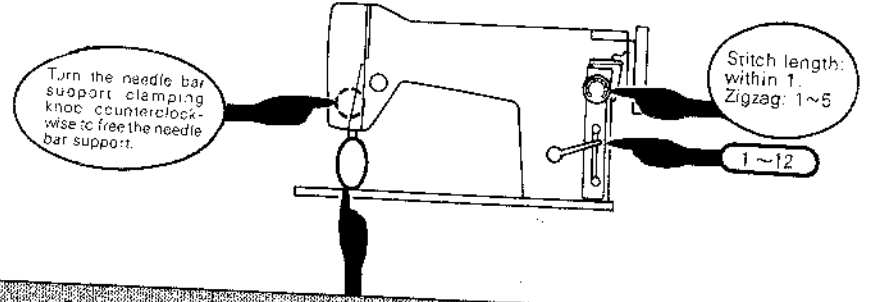

Presser	Needle plate	Feed dog	Bobbin case
			Pass the thread through the eye. 
Zigzag	Zigzag	Zigzag	

As for replacement of parts, see the following pages.  
 Presser foot and needle plate : page 7  
 Feed dog : page 8  
 How to thread into bobbin case : page 12

(1) Tension control of zigzag stitch

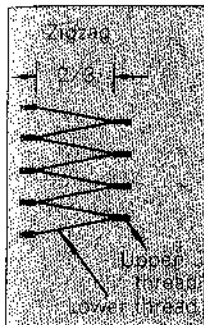

On the reverse side of swatch, the lower thread should form 2/3 of the stitch width.

How to control the tension.  
See "Tension control of straight stitch" (page 20). Also set the upper thread tension a little weaker than that of straight stitch.

(2) Satin stitch

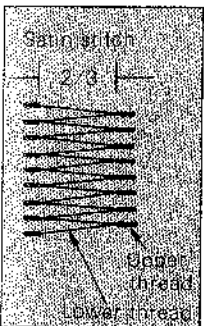

Satin stitch is a kind of zigzag stitch with very fine stitch length.

- (3) Beginning
- (4) How to fasten the final sewing
- (5) How to change the sewing direction
- (6) Finish sewing

See page 19.

**Caution** When the machine stops sewing passing the needle through the swatch, do not move zigzag lever, in order to avoid needle breakage and needle bend.

Sewing lace on

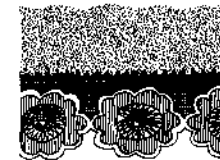
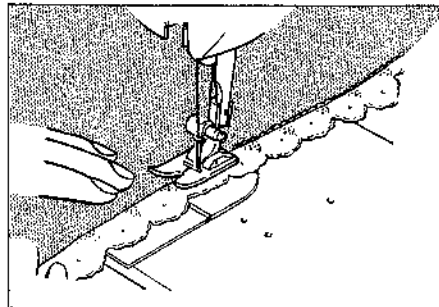

Patching up

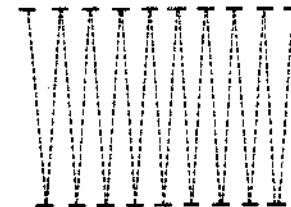
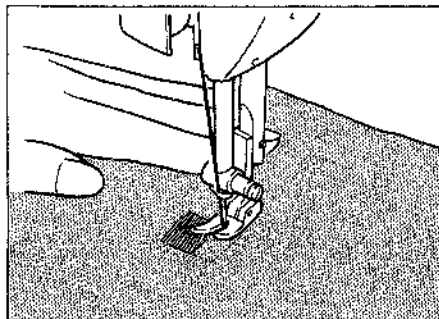

Shirring

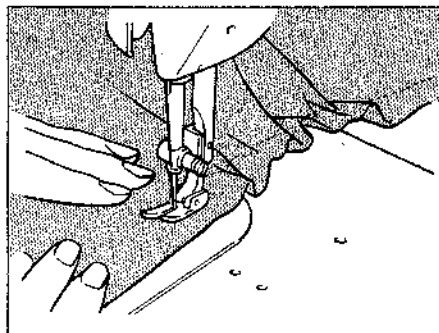

### Tacking a padding

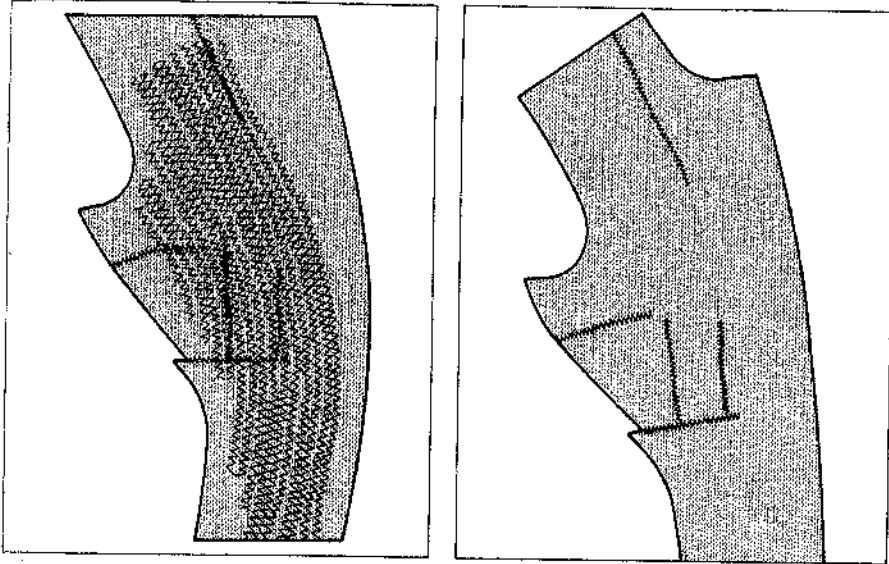

### Reinforcing stitching

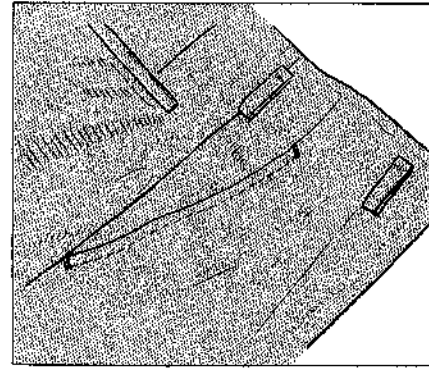

### Overlock and hem stitch

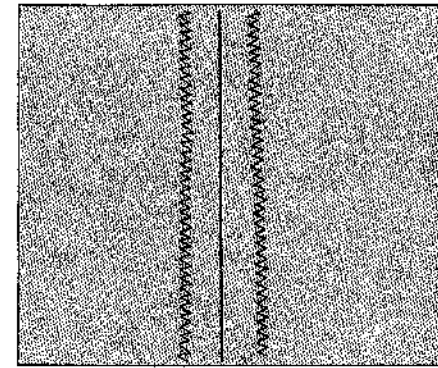

### Coat hemming

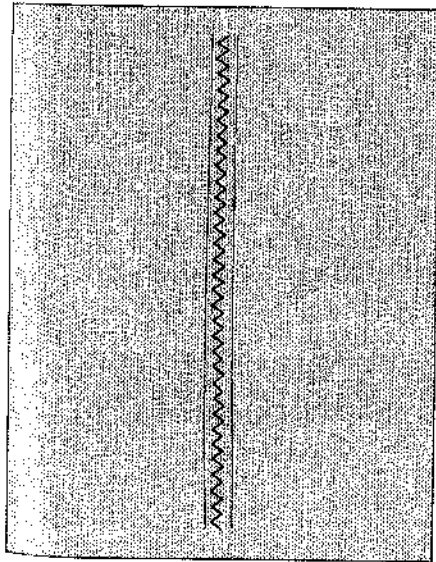

### Trouser waist lining

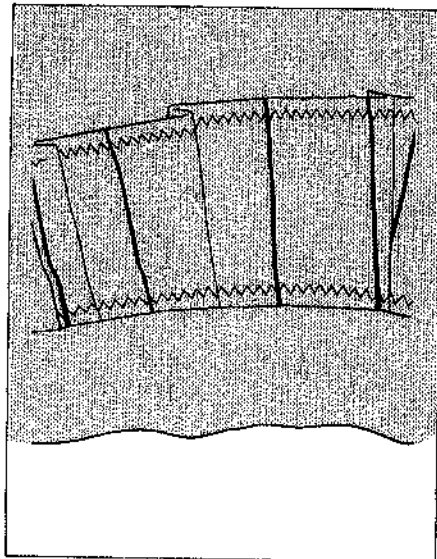

### Embroidering

#### (1) How to use the embroidery frame

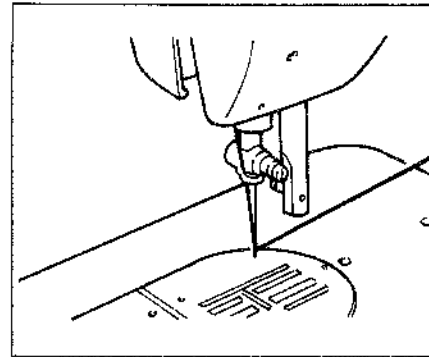

1. Remove the presser foot and feed dog.
2. Use the needle plate for 12 mm wide zigzag stitch.
3. Use the auxiliary upper thread tension regulator.

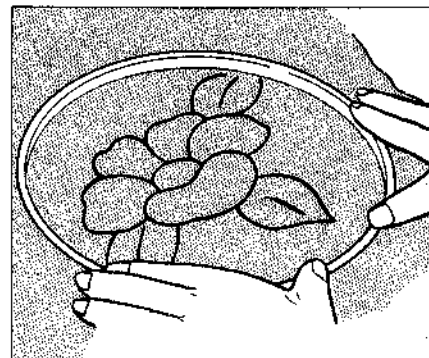

4. Place material in the embroidery frame:  
Place the cloth over the outer ring, with the drawn pattern up. Put the inner ring on and press it down. If the cloth is slack or distorted, make it taut by means of the adjusting screw on the outer ring.

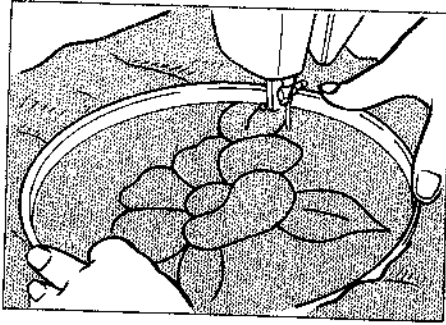

5. Place the frame under the presser bar.

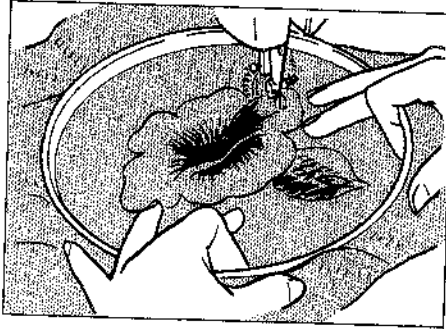

6. Holding the frame:  
In ordinary cases, use both hands—thumbs and forefingers for holding the frame, middle and ring fingers on the cloth, and small fingers on the outer ring.

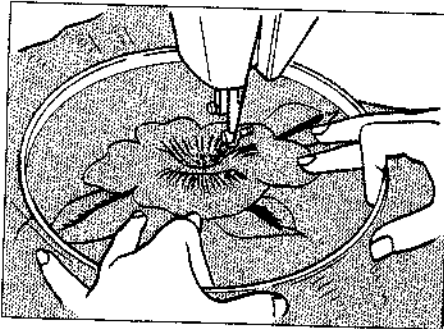

7. Moving the frame:  
While holding the frame slightly downward so that the cloth stays close to the needle plate, move the frame gently according to the embroidery design.

## (2) Embroidering and monogramming

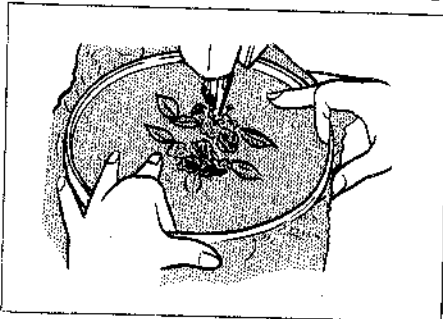

**Note:** Refer to Item 2 "Knee-operated zigzag width adjuster, Function and operation", Section 1, Chapter III, when using it for adjusting zigzag stitch width.

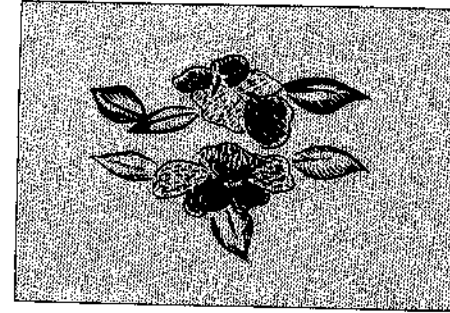

**Embroidering**

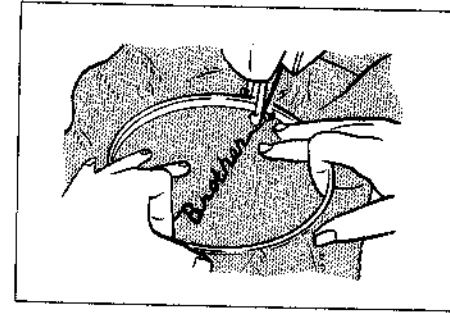

**Monogramming**

## Cleaning of Feed Dog and Shuttle Race Body

- Remove the needle, presser foot and needle bed.  
 How to remove needle ..... See page 4  
 How to remove presser foot ..... See page 7  
 How to remove needle bed ..... See page 7.

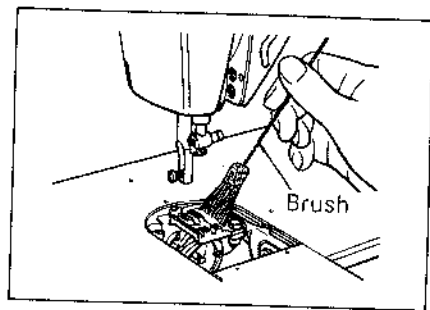

- Clean the feed dog and shuttle race body with brush.

**Caution** When you clean the shuttle race body, oil a few drops and after that, wipe the oil in order to avoid the stain on stitches with oiled threads.

When finishing cleaning, restore the above-mentioned parts to the machine.

## Oiling

Oil the following portions with the oiler of the standard accessory.

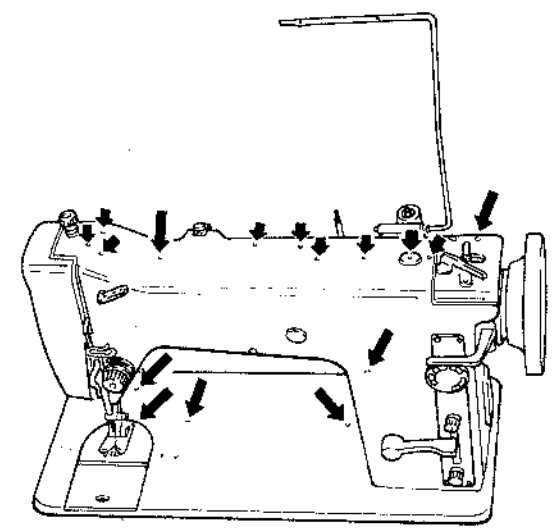

	Description
<b>1. Kind of oil</b>	Use the attached oil Replacement: use the oil for Brother Sewing Machines
<b>2. Interval of oiling</b>	Once or twice in a week
<b>3. Quantity of oil</b>	↓ → Oil 2 or 3 drops ↓ → Oil 4 or 5 drops Do not oil too much
<b>4. Caution</b>	1. When oiling, do after sewing. 2. After oiling, run the machine without thread and with the presser foot up. 3. Test sewing. 4. Wipe off the excess oil completely.

When you use the machine everyday, oil once a day.

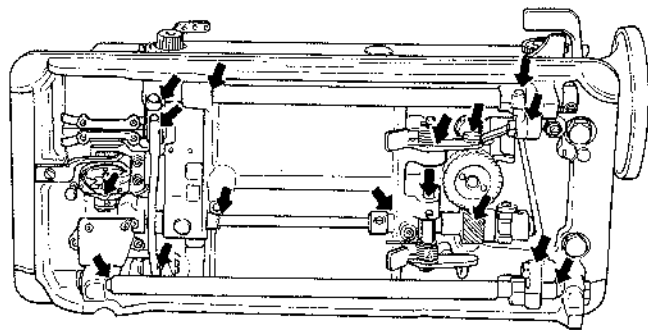
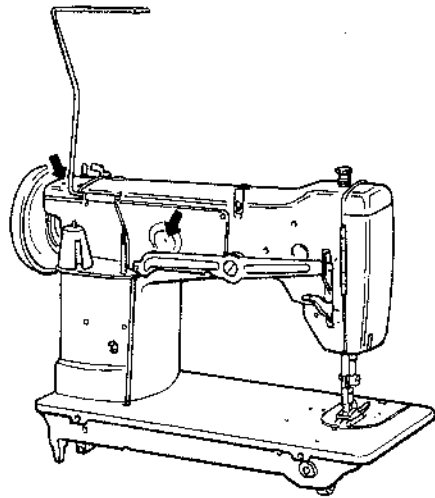
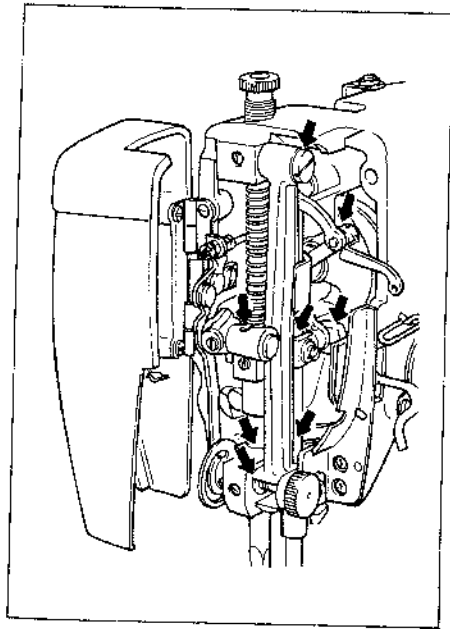

## Basic Adjustments

### Adjustment of the bobbin winder guide

Unproportional winding may cause a bad condition of the lower thread.

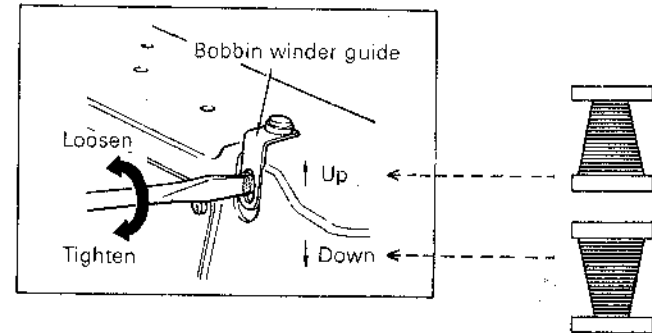
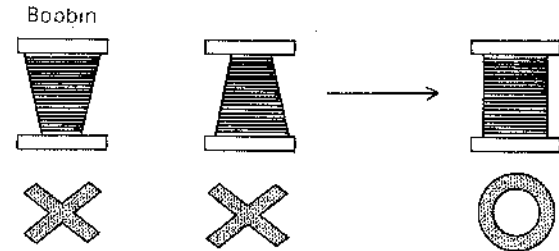

### Adjustment of the thread take up spring

If the regulator thumb nut cannot give a good condition of the upper thread, adjust the strength or the quantity of motion of the thread take-up spring.

#### (1) Adjustment of the strength of the thread take-up spring

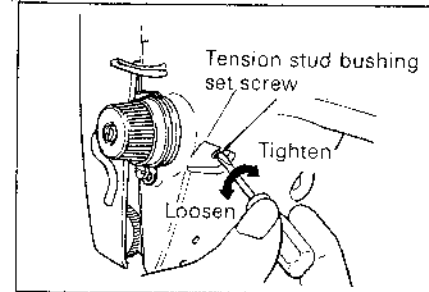

Too strong thread take-up spring may cut the upper thread, and too weak one may let the thread get into the shuttle body.

1. Loosen the tension stud bushing set screw.

## Trouble and Check Point

This sewing machine is so designed as not to require difficult and professional adjustments. Remember the following troubles which may possibly appear when basic adjustments are forgotten.

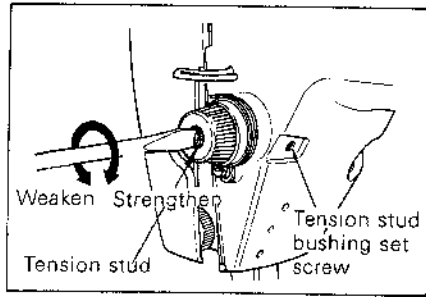

2. Adjust the thread take-up spring by the tension stud.
3. Tighten the tension stud bushing set screw after adjustment.

### (2) Adjustment of the quantity of the thread take-up spring

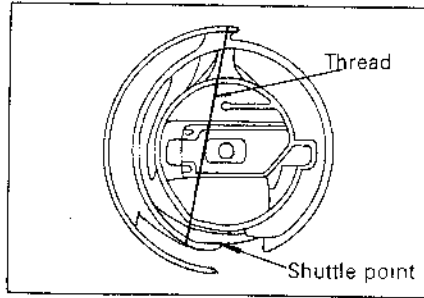

If the quantity of motion of the thread take-up spring is properly adjusted, the thread take-up start operating when the shuttle point comes to around the lowest position after catching the thread.

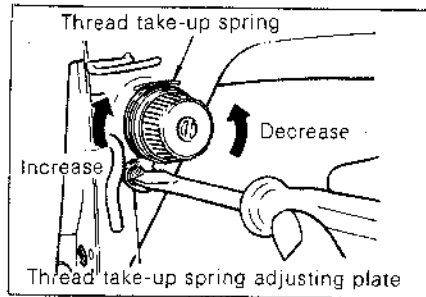

Too much quantity of motion may cut the upper thread, and too less one may let the thread get into the shuttle body.

Trouble	Cause	Check Point
1. Material not feeding	Light pressure of presser foot	Increase the pressure by turning clockwise the presser adjusting screw
	1) Needle bends or the top of needle is not sharp.	Change the incorrect needle to new one
	2) Improper setting of needle	Set needle correctly. (See page 4)
	3) Swatch is pulled while sewing	Do not pull or depress the material which sewing
3. Upper thread breakage	4) Improper combination of needle, thread and material.	In accordance with the material, select proper thread and needle. (See page 17)
	1) Incorrect threading of upper thread	Thread correctly (See page 14)
	2) Threading at incorrect position	Make sure that threading is not made at incorrect
	3) Too strong thread tension	See page 20 for straight stitch, or 22 for zigzag stitch
	4) Incorrect setting of needle	See page 4
	5) Use of wrong needle	See page 4
	6) Use of thicker needle than the needle hole	See page 17
2. Needle breakage	7) Scratch on shuttle hook	Small flow → burnish with sandpaper #800 Big flow → repair is needed.
	1) Incorrect threading of lower thread	Thread correctly (See page 12)
	2) Too strong tension of the tension spring of the bobbin case	Adjust the tension by turning counterclockwise the countersunk screw on the tension spring. Decrease the tension of the upper thread also, otherwise the thread tension will not be good
	3) Scratch on shuttle	Small flow → burnish with sandpaper #800 Big flow → repair is needed.

## How to Set the Machine

<b>5. Skipping stitches</b>	1) Needle bends or the top of needle is not sharp	Change the incorrect needle to the new one (See page 4)
	2) Improper setting of needle	Set correctly (See page 4)
	3) Using wrong needle	Use the needle No. DB X 1
	4) Dusty needle plate	Remove the needle plate and clean it
	5) Improper combination of needle, thread and material	In accordance with material, select proper thread and needle (See page 17)
	6) Incorrect threading	Thread correctly (See page 14)
<b>6. Uneven seams</b>	Improper tension of upper/lower thread.	Set to proper tension
<b>7. Crumple of material</b>	1) Too strong thread tension	When sewing thin material, set the thread tension at looser position
	2) Incorrect threading	Thread correctly (See page 14)
	3) Too strong pressure of presser foot	Reduce the pressure by turning the presser adjusting screw counterclockwise

### Table and leg

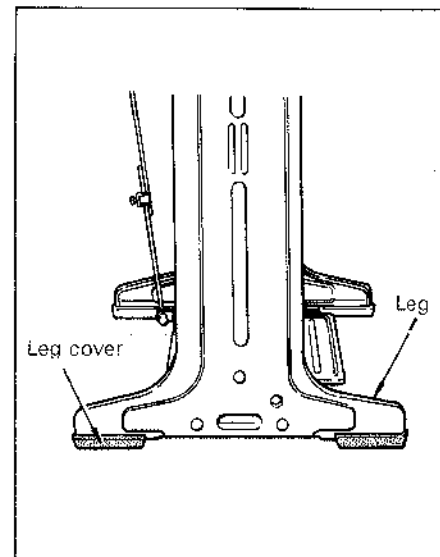

Take off the crate of table and legs and put the leg cover to the bottom portion of legs.

### Head

Take the head out of the crate.  
Wipe out the anticorrosive oil thoroughly.

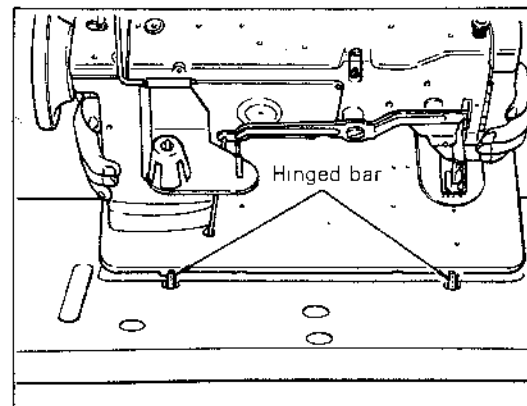

1. Raise the hinged bars and insert them into the matching holes on the side of the machine bed.

## Specifications

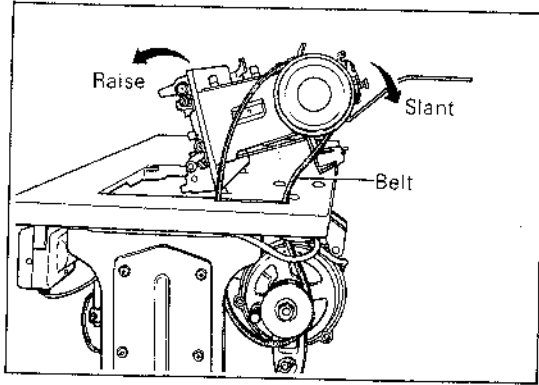

2. Slant the machine on the other side toward you and put the belt around the pulley and belt wheel.

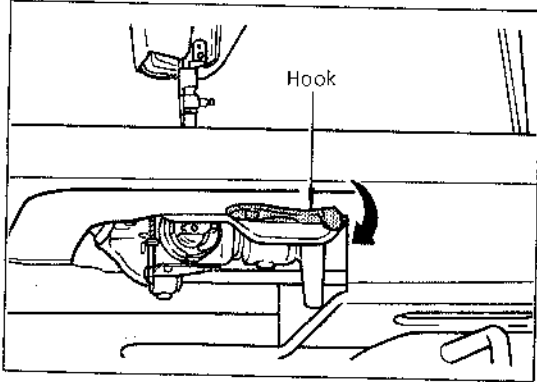

3 Mount the head on the table and fasten it by means of a hook under the table.

Max. sewing speed	Hand-cranked 1200 stitches/m Motor-driven 1800 stitches/m
Max. stitch length	0 ~ 5 m/m
Max. zigzag stitch width	12 m/m
Needle bar stroke	35 m/m
Thread take-up lever stroke	61 m/m
Presser foot high (Standard)	6 m/m
Feed dog high	1 m/m
Normal needle position	Center base line
Needle used	CB × 1 #9 ~ #18
Size a ..... 138 m/m b ..... 224 m/m c ..... 399 m/m d ..... 178 m/m	